



OPERATING MANUAL

Read carefully before using the device
and save these instructions.

Table of contents	page
Air temperature table	3
Safety Instructions	4
Product overview	5
Application and operation	6
General	6
Overview of plants	6
Influencing factors on vaporization.....	7
Starting Up	8
Cleaning and maintenance	11
Mouthpiece, valve and filling chamber	11
Disassembly of the mouthpiece	11
Disassembly of the valve	12
Disassembly of the filling chamber insert ..	13
Disassembly of the filling chamber	13
Attachment of the balloon to the valve	14
The hot air generator	15
Technical Data	16
Declaration of conformity	16
Warranty	17

AIR TEMPERATURE TABLE

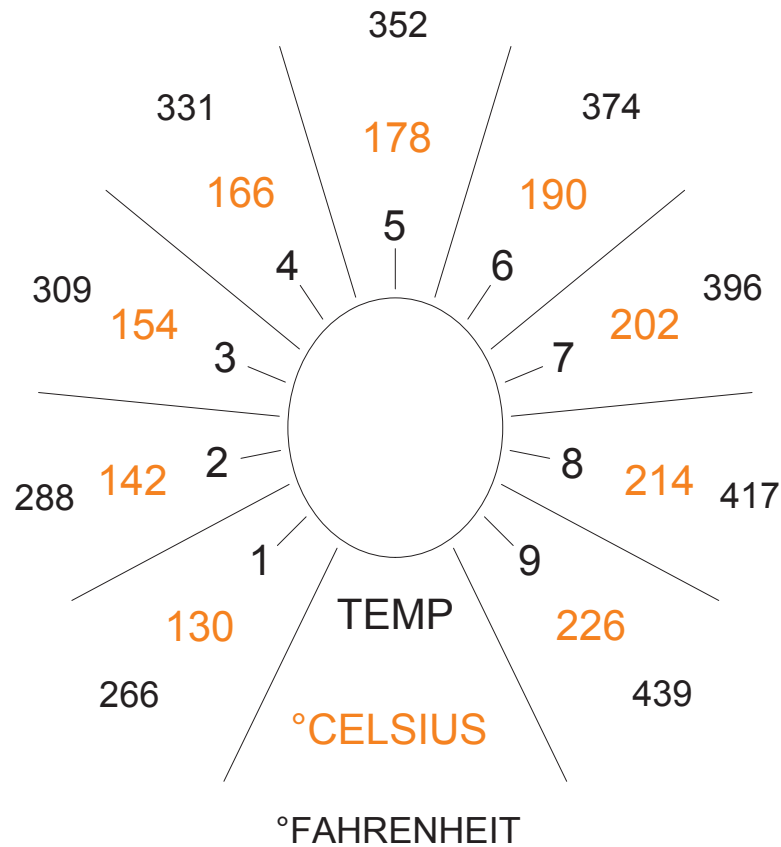

The air temperature fluctuates around $\pm 5^{\circ}\text{C}$ within the declared value due to the heating and cooling off process of the heating block. For example at the setting of 6 the actual temperature will be between $185\text{-}195^{\circ}\text{C}$.

The temperature is measured (when the air is streaming) in the middle of the filling chamber at the lower screen with a fast reacting, electronic thermometer.

Cellulose (organic material or plant material) has a point of spontaneous combustion at 235°C (455°F) and higher.

SAFETY INSTRUCTIONS!

Attention

When using a product that generates hot air, it is vital to follow the following preventive safety guidelines to avoid the risk of fire, explosion, electrical shock and bodily injuries. Read and follow these instructions attentively before using this product. Keep these instructions in a safe place.

Warning

Danger! This product must be unplugged before opening it, as live components and connections are exposed. Don't put any objects into the openings of the device. This product is not to be used in damp or wet conditions. Do not use in the bathroom or over water. Do not expose the appliance to rain. Do not use in an explosive atmosphere or when there is a risk of ignition.



Safety instructions

This symbol will always give information regarding the user's safety. Always pay close attention to it.



Note / Tip

This symbol always gives you technical information or useful tips regarding this product.

Caution

The voltage rating stated on this product ($V = \text{Volt}$) must correspond to the main voltage. This product is only to be connected to a properly ground socket. Do not leave this product unattended when in use. This product is not to be operated by children. The ventilation slots as well as the exhaust vent are not to be grasped, covered or obstructed in any way during operation or during the cooling-down period. Can cause burns! Do not touch the neck of the exhaust vent or the filling chamber while it is still hot. Only attach the filling chamber to the exhaust vent while filling the balloon. After filling the balloon the filling chamber has to be removed from the exhaust vent to avoid an overheating of the filling chamber (Causes burns!). Do not put any bodily parts or objects in the hot air flow. Only use this product on a stable flat surface. Do not misuse the power cord. Do not carry this appliance by its power cord and do not use the power cord to pull the plug out of the socket. Protect the power cord from heat and sharp edges. If the device or the power cord have visible or invisible damages it is not to be operated anymore until it is repaired. Store properly. Let this appliance cool down properly before it is stored away. When this product is not in use, it should be stored in a dry enclosed area out of the reach of children.

PRODUCT OVERVIEW

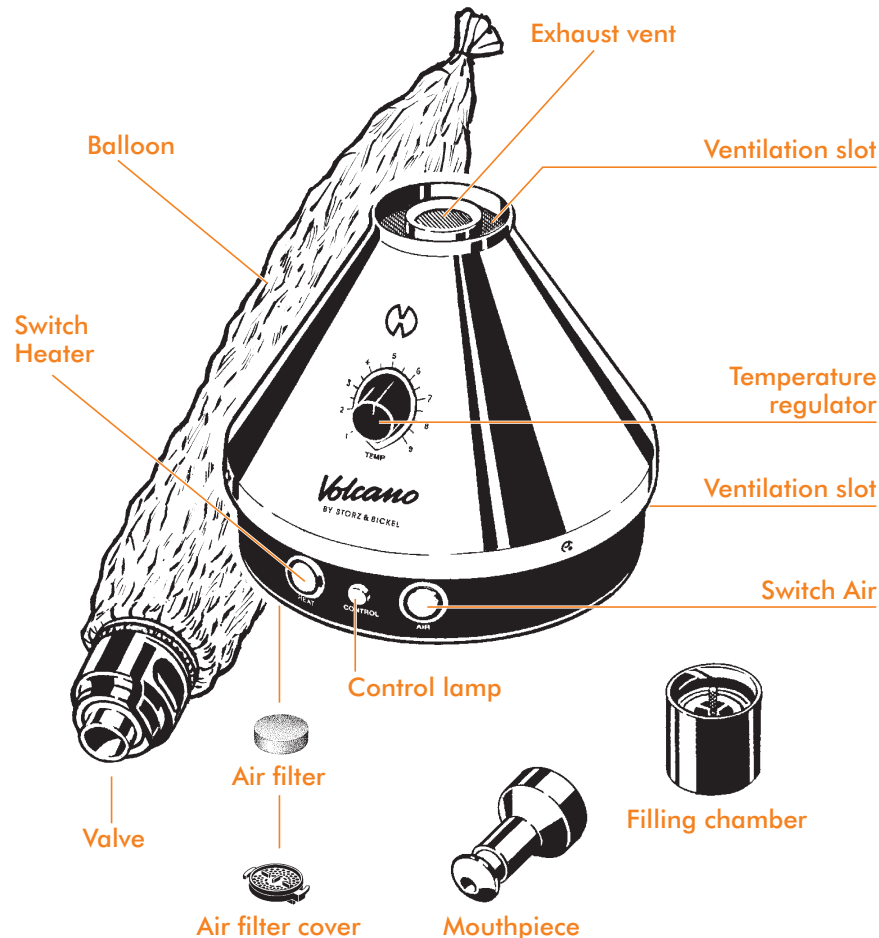

APPLICATION AND OPERATION

General:

The VOLCANO-System-Vaporizer releases flavor and active ingredients from plant material through vaporization by hot air. With the vaporization technique hot air passes through the plants listed below. During this process the flavoring and active ingredients will be set free through controlled temperature (130-230°C). Due to the specific vaporization temperature of the plant material the ingredients are released into the air and can subsequently be inhaled.

Smoking or incensing releases ingredients through heat but the temperature is reached through combustion which has several disadvantages. Smoking involves the combustion, incensing the carbonization of plant material, followed by the unavoidable inhalation of toxic combustion by-products, which cause irritation of the respiratory tract as well as noxious odors. In addition, the high and uncontrolled combustion temperature causes the unnecessary destruction of the majority of the ingredients, thus squandering the original material.

Overview of plants:

Below is an overview of the plants which are suitable for vaporization in the VOLCANO. The aromas of the following plants can help us to escape from our hectic and stressful daily lives.

Plant Name	Botanical Name	Commonly used part of the plant	Temperature Setting
Eucalyptus	<i>Eucalyptus globulus</i>	the leaves	1 / 130°C (266°F)
Hops	<i>Humulus lupulus</i>	the cones	3 / 154°C (309°F)
Chamomile	<i>Matriarca chamomilla</i>	the blossoms	6 / 190°C (374°F)
Lavender	<i>Lavandula angustifolia</i>	the blossoms	1 / 130°C (266°F)
Lemon Balm	<i>Melissa officinalis</i>	the leaves	2 / 142°C (288°F)
Sage	<i>Salvia officinalis</i>	the leaves	6 / 190°C (374°F)
Thyme	<i>Thymus vulgaris</i>	the herb	6 / 190°C (374°F)

Please note: The VOLCANO Vaporizer is not designed for medical-therapeutic purposes. If you have any health problem consult your doctor or pharmacist. You may notice that the one or more plants may cause an allergic reaction. In such a case you are urgently recommended to refrain from using the plant causing such a reaction. Only use the plant parts which are found in this list and which have been verified according to the regulations of the European or any other pharmacopoeia with regard to genuineness, purity and pathogenic germs. You can purchase such plants or plant parts in pharmacies.

Influencing factors on vaporization:

The amount of active ingredients released into the balloon can be influenced by the following factors:

1. Quality: The concentration of ingredients in the plant material
2. Quantity: The amount of plant material in the filling chamber.
3. Surface: The finer the plant is grinded, the greater the surface and the more ingredients can be released during vaporization.
4. Temperature: The higher the temperature, the more active ingredients will be released at once. Please note: Increasing the temperature should be the last resort, because plant material tastes more roasted when using higher temperature.

The ingredients of a plant are released in a gentle way so that a repetition of vaporization with the same material in the filling chamber is possible. Depending on the 4 factors described above, the material in the filling chamber can be reused several times until all aromas and active ingredients are completely dissolved. It is advised to take out the content of the filling chamber and grind it once again to increase the surface of the original material. An increased temperature would activate more ingredients as well, but has a negative effect on the taste.

It is important to watch the vapor density in the balloon. A fine, white vapor feels very comfortable when inhaled. As the vapor gets denser the taste can get too strong. In case of a very high vapor intensity (density) the concentration of aromas and active ingredients can cause an irritation of the respiratory tract. If this is the case lower the temperature.

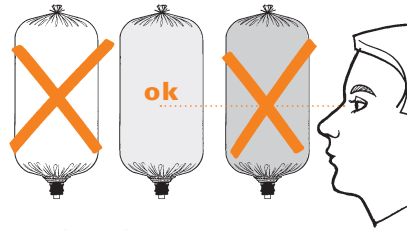

Watch vapor density

Respiration: Inhale only half of the volume of air that one could inhale. Hold your breath for a few seconds and exhale slowly. It is recommended to consciously concentrate on your respiration.

For current and detailed information please visit our website: www.storz-bickel.com

Starting Up:

 Place the VOLCANO on a flat and solid surface. Check if the main voltage corresponds to that shown on the appliance. The power cord and plug must be in perfect condition. Only connect the VOLCANO to a properly installed (grounded) socket.

1. Temperature setting and heating up: Turn the temperature regulator knob to the desired setting and switch on the heater by pushing the red button „HEAT“.

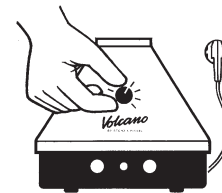

Choose temperature

The red switch will light up signalling that the heater is in operation. At the same time, the yellow control lamp will be signalling that the appliance is heating up. This process can take up to 5 minutes depending upon the chosen temperature.

As soon as the yellow control light goes off, the desired temperature has been reached and heating up of the heating block is completed. If the temperature in the heating block drops, the heating block will automatically heat up, which is signalled by the yellow control lamp lighting up again.

2. Filling the filling chamber: Remove the entire filling chamber insert and fill the chamber with the desired amount of herbs.

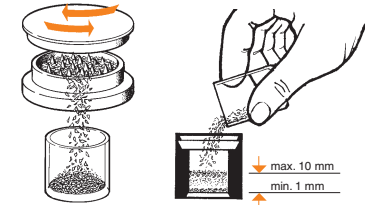

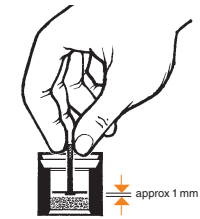

Fill filling chamber

3. Fit in the filling chamber insert and use the pin to lower the screen unit so that the content of the filling chamber is loosely fixed between the screens. Make sure that the filling chamber disc sits properly in the filling chamber. It must touch the top edge of the filling chamber cylinder.



Insert filling chamber insert

 Causes burns! Do not touch any part of the filling chamber, including the screen unit, after filling the balloon until they have cooled down.

 Take care that the screens are neither bent nor obstructed with plant material. To guarantee optimal results, it is advised to clean the screens regularly.

4. Put the filling chamber on the exhaust vent of the VOLCANO. Turn on the air pump, by pushing the green switch „AIR“. This switch will light up signalling that the air pump is operating. The filling chamber and its content have to be preheated for a couple of seconds before the ingredients will start to vaporize.



Preheat substance when yellow control lamp is off

5. Attach the valve with the affixed balloon to the filling chamber. To do this, set the valve onto the filling chamber from above until both gripper elements are engaged. The valve will automatically open up. The balloon will slowly fill with the vaporized aromas and active ingredients.

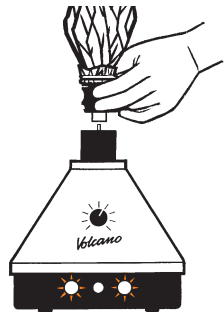

Attach valve balloon to filling chamber

6. Only fill the balloon with the approximate amount of vapor that you intend to use within the next 5 minutes. Do not overfill the balloon (overpressure) in order to prevent the loss of vapor and its active ingredients. It is important to watch the vapor density (as described under influencing factors on vaporization, page 7)

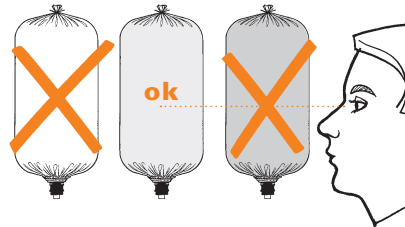

Watch vapor density as described

7. When the balloon is filled, turn off the air pump and remove the balloon unit. Grasp the valve firmly with your thumb and index finger at the designated indentation.

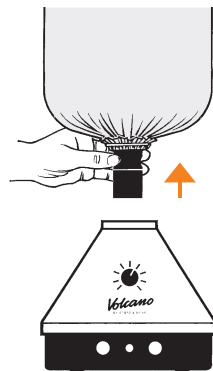

Remove complete balloon unit

8. Place the filling chamber on a heat-proof surface, for example these instructions, and detach the valve balloon from the filling chamber by pressing the grippers together. The valve closes automatically so that the vapors in the balloon cannot escape.

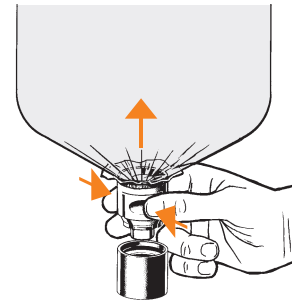

Detach valve balloon from filling chamber

! 9. Causes burns! Never leave the filling chamber on top of the exhaust vent of the VOLCANO as long as the heater is on, except when filling the balloon. Non-observation can lead to an overheated filling chamber, which might cause burns.



Caution! Causes burns!
Never leave filling chamber on VOLCANO

10. Attach the mouthpiece to the valve balloon. Make sure that both grippers are engaged.

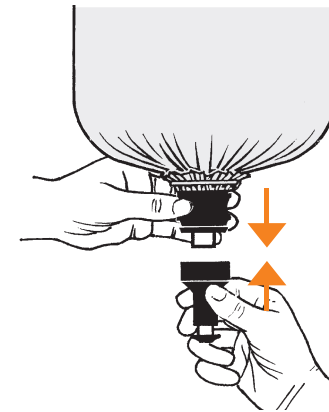

Attach the mouthpiece to the valve balloon

11. To inhale, put the mouthpiece to your lips and lightly press against the mouthpiece with your lips.

By doing so, the valve opens and the vapors can be inhaled from the balloon. As soon as you remove the pressure from the mouthpiece, the valve automatically closes.

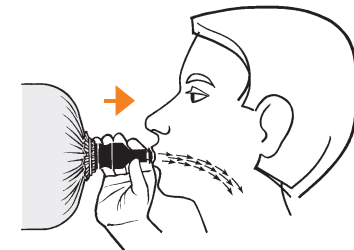

Press mouthpiece against lips to inhale

CLEANING AND MAINTENANCE

Mouthpiece, valve and filling chamber:

These parts should be cleaned regularly to guarantee proper functioning and a clean taste. For hygienic reasons cleaning should also be done when the device is used by other persons. Always replace the balloon after cleaning has been done. Only use spirit (ethyl alcohol) and paper or cotton towels.



Manual cleaning with alcohol (min 90%)

The mouthpiece, valve and filling chamber are easily disassembled within seconds for cleaning. Mouthpiece, valve and filling chamber may also be cleaned in a dishwasher. The screens and the parts of the filling chamber insert are too small for that and might get lost in a dishwasher.

Disassembly of the mouthpiece

Pull off the lip piece from the mouthpiece cylinder and remove the cylinder from the mouthpiece housing.

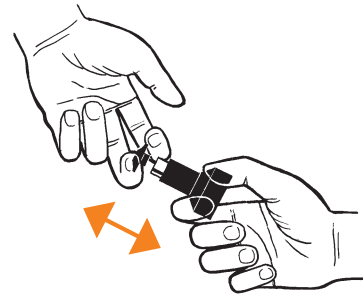

Pull off lip piece

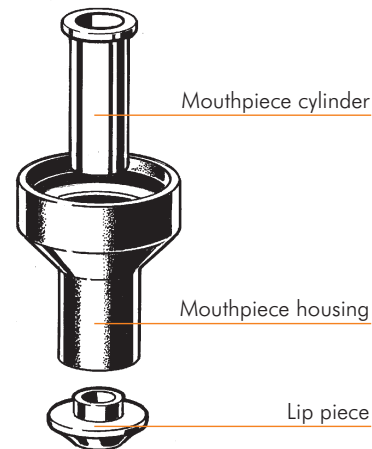

Reassemble in reverse sequence.

Disassembly of the valve

Take the balloon including the fixation rings off. Insert your index finger into the open end of the valve cylinder. Push the valve cylinder out until you can unscrew the valve cap.

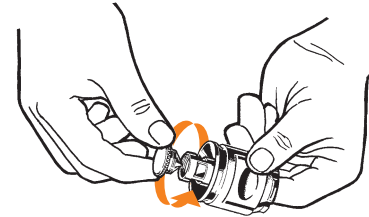

Screw off valve cap

Remove the valve cap and valve ring. Pull the valve cylinder along with the valve spring out of the valve housing.

In case of tightness, the parts can be loosened by warming them up in warm water.

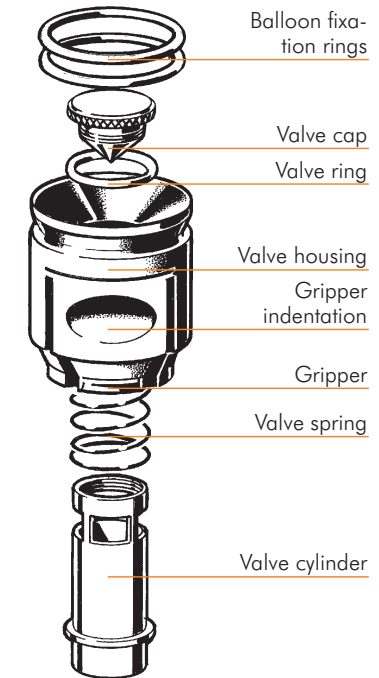

Reassemble in reverse sequence.

Disassembly of the filling chamber insert

The filling chamber insert can be easily removed from the filling chamber. The filling chamber insert can be disassembled by screwing off the nut.

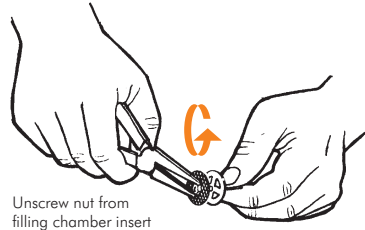

Unscrew nut from filling chamber insert

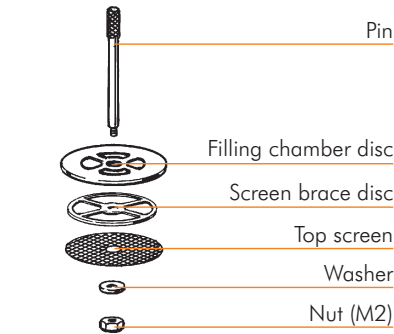

Reassemble in reverse sequence.

Disassembly of the filling chamber

The lower screen will be pushed out of the filling chamber. The filling chamber ring can be pulled off with tweezers

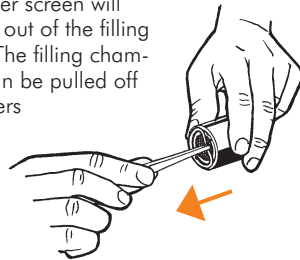

Pull off filling chamber ring with tweezers

Filling chamber housing and filling chamber cylinder can be screwed off now. In case of tightness, the parts can be loosened by warming them up in warm water.

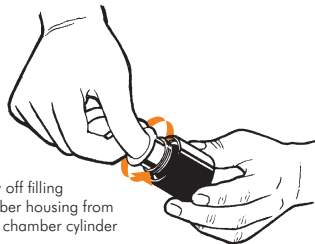

Screw off filling chamber housing from filling chamber cylinder

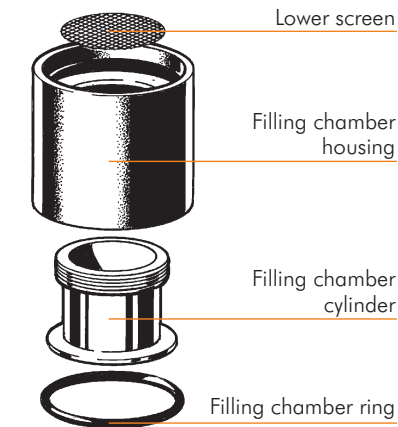

Reassemble in reverse sequence.

Attachment of the balloon to the valve

Use a tasteless, heatproof and foodsafe oven hose, which is used in the food industry. It is available in nearly every drug store and supermarket. Do not use any other plastic bags or clingwraps. The procedure to change a balloon with a heatproof oven tube is described below:

Cut a piece of approximately 50-60 cm and tie it closed at one end

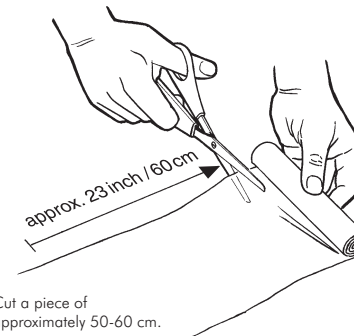

Cut a piece of approximately 50-60 cm.

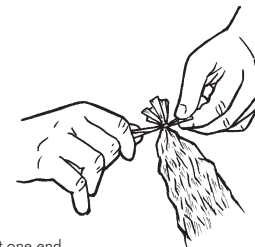

Tie close at one end

As the opening of the tube is much wider than the diameter of the valve housing, the oven tube must be folded. To do this pull one of the balloon fixation rings approximately 3 cm over the open end of the oven tube and then pull the first balloon fixation ring with the oven tube over the collar of the valve until it fits into the intended notch.



Attach the oven tube to the valve

Adjust the folds equally around the valve collar making certain that the valve hangs straight down when the oven tube is held at the end.

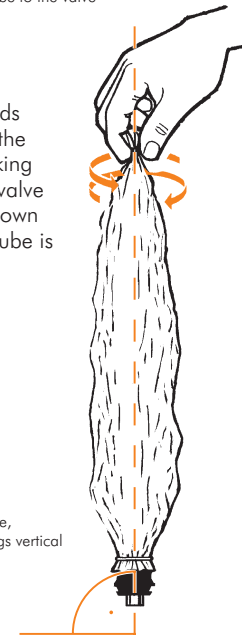

Align the oven tube, that the valve hangs vertical

Bend the remaining end of the tube back. Secure the oven tube by rolling the second balloon fixation ring over both the valve and the first balloon fixation ring so that the first balloon fixation ring is no longer visible and the remaining end of the oven tube is folded backwards.

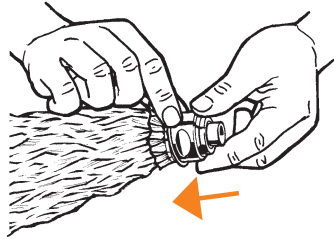

Secure the oven tube with the second ring

If needed, the excess oven tube material can be trimmed away using a pair of scissors, making certain not to poke a hole into the balloon.

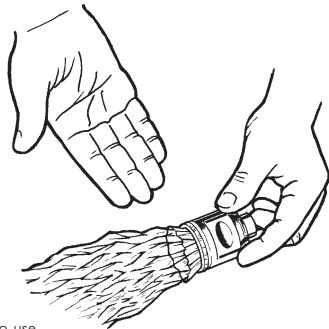

Ready-to-use



Balloonhose-sets can be ordered directly from www.storz-bickel.com.

The hot air generator (VOLCANO)

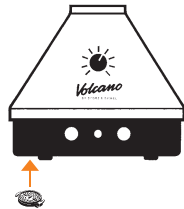

At the bottom of the hot air generator is an air filter. The air filter can occasionally be inspected by turning the air filter cover counter clockwise and remove the air filter. Only clean the device with a damp cloth when dirty. Do not use any harsh cleaning agents or scouring powder.



Remove the plug from the socket before cleaning. Do not spray fluids into the ventilation slots! Should fluid penetrate into the product, allow sufficient time for it to dry out before use.



Do not attempt to open the VOLCANO! Without the special tools, any attempts to do so will cause damage to this product and invalidate the warranty.

TECHNICAL DATA

Voltage: 220-240 V / 50 Hz or 110-120 V / 50-60 Hz

The specification is located on the bottom side of the VOLCANO hot air generator.

Heat Output: 125 W

Air pump Output: 6 W

Air Temperature: Adjustable between approximately 130°C to 230°C

Air Flow: 9 l/minute

Safety Category 1 Device

Please unplug to disconnect from the main current.

Subject to technical changes.

Patents: DE Pat. 198 03 376; DE 100 42 396; EU 0933093; US Pat. 6,513,524; further international patents pending.

DECLARATION OF CONFORMITY

This device complies with the following EC Directives:

Low Voltage Directive 73/23/EWG

Electromagnetic Compatibility 89/336/EWG

WARRANTY

Warranty

We offer a three year warranty on this product. The warranty period begins on the date of purchase. During the warranty period we or an authorized repair shop will repair or if necessary replace any defects in the appliance free of charge, when such defects occur during proper usage of this product in accordance with the directions given in this instruction booklet and arise solely from faulty design, materials or workmanship provided that the defective product has been returned to Storz & Bickel or one of our authorized repair shops. Damage, or defects that occur due to improper handling or maintenance of this product are not covered under warranty. The foregoing shall constitute our sole liability under this warranty. There is no entitlement to any refund of the purchase price whether in whole or in part and we shall not be liable under this warranty for any damage, direct or indirect caused by the product during usage or otherwise. This warranty does not affect or in any way limit your statutory rights. Wear and tear on parts are excluded from the warranty. Claims under this warranty will only be granted if the product, not disassembled, along with the sales slip or invoice stating the date of purchase and dealer's stamp is sent, well packaged either to us or one of our authorized repair shops.

Repair Service

Our Customer Service Department or one of our authorized repair shops will repair faults not covered by the warranty or after said warranty has expired.

Liability

Handling of this product is to be as stated in the operating manual. The user accepts full liability for improper handling and usage of this product. The intended application only refers to the plants named by us. Repair of this product is only to be done by us or one of our authorized repair shops. For repairs done by one of our repair shops, proof of the following must be presented: repair date, type and extent of repair as well as the company's name and signature. Only original Storz & Bickel parts are to be used.

Failure to comply with any of the points mentioned in this operating manual release Storz & Bickel GmbH & Co. KG from any and all liability.



STORZ & BICKEL GMBH & CO. KG

Rote Strasse 1 · 78532 Tuttlingen/Germany
Tel. +49-7461-969707-0 · Fax +49-7461-969707-7
eMail: info@storz-bickel.com
www.storz-bickel.com



STORZ & BICKEL AMERICA, INC.

1155 5th Street #104, Oakland, CA 94607-2501, USA
phone: 510-451-1553 · fax: 510-451-2053
eMail: oakland@storz-bickel.com
www.storz-bickel.com